

# Elspec lichtmanagement systemen



Proef de techniek.



# Elspec

*Openbare verlichting besturingsystemen:*

Langmatz EFR ontvangers  
Draadloos schakelen via lange golf.

Sogexi  
Powerline lichtmanagement.  
Stand-alone dimmen.  
Retrofit combinatie.

Eurel LM  
Draadloos lichtmanagement.





Langmatz EFR



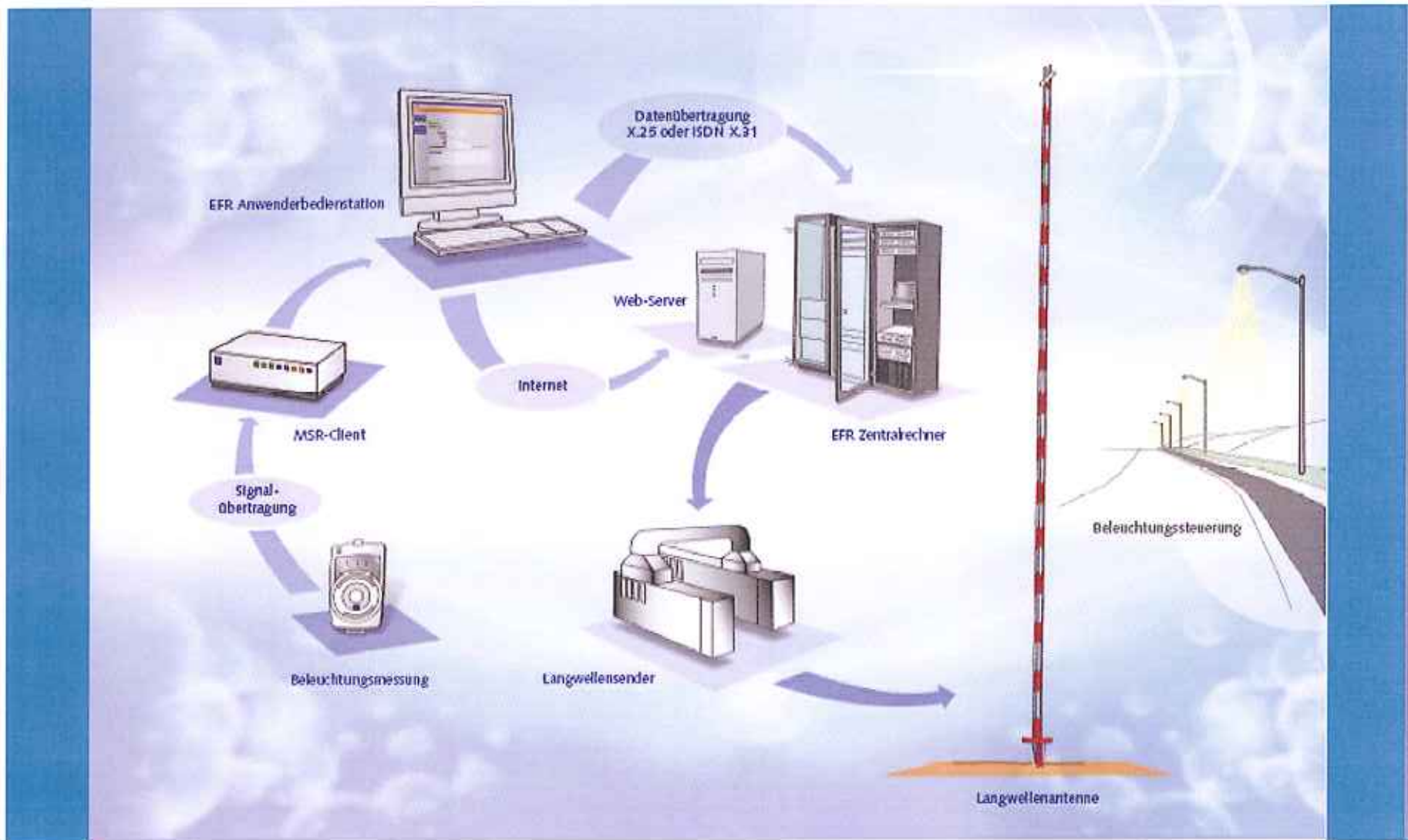

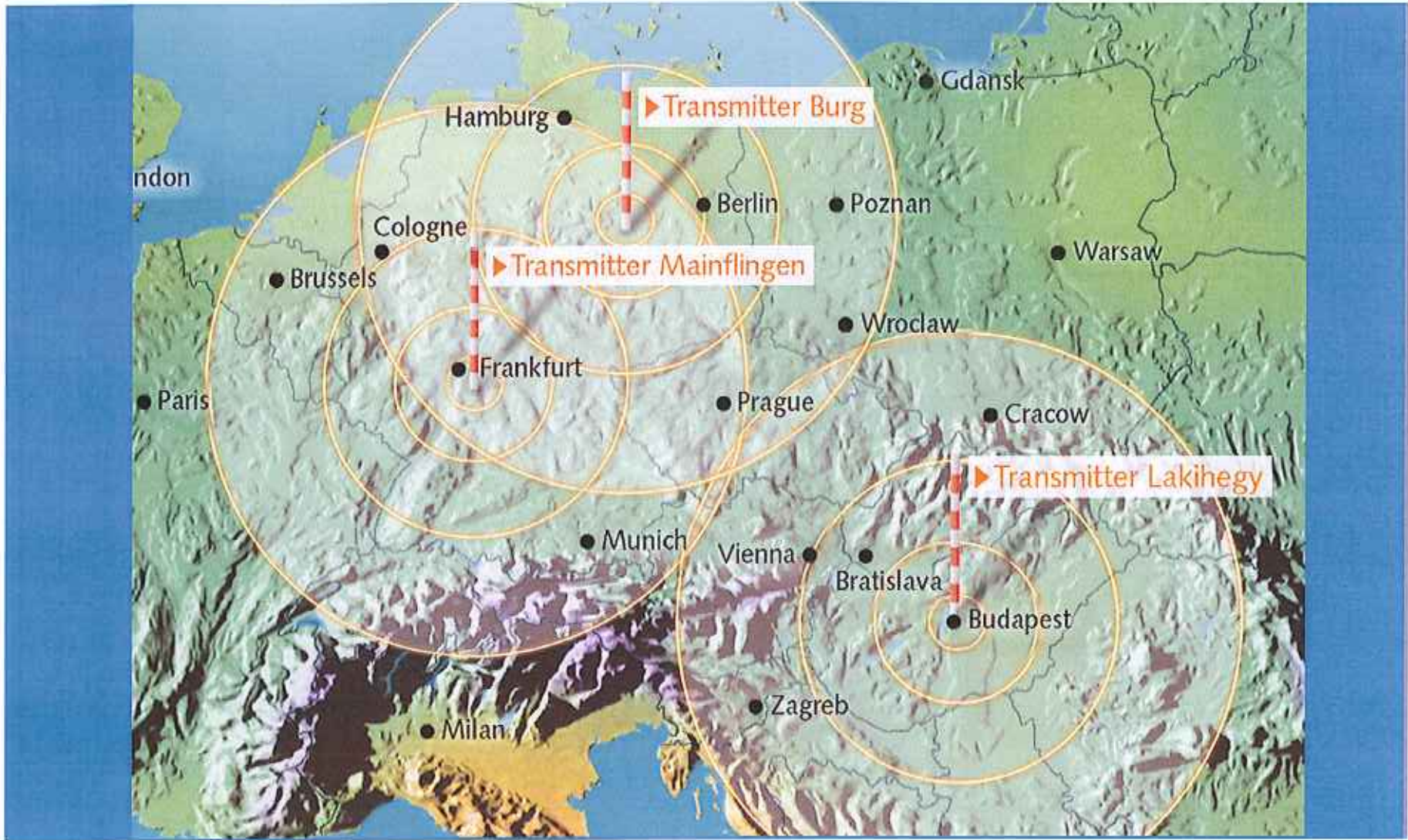

# EFR-Europäische Funk-Rundsteuerung

Schakelen met Lange golf radio techniek (DCF)

- Frequentie: 129,1 kHz en 139,0 kHz
- Telegramformaat: Semagyr-Top of Versacom

Programmering voor:

- Jaar schakelprogramma
- Zon en feestdagen
- Astronomische klok

EFR prijsmodel:

- Vast contract
- Prepaid
- Autonoom

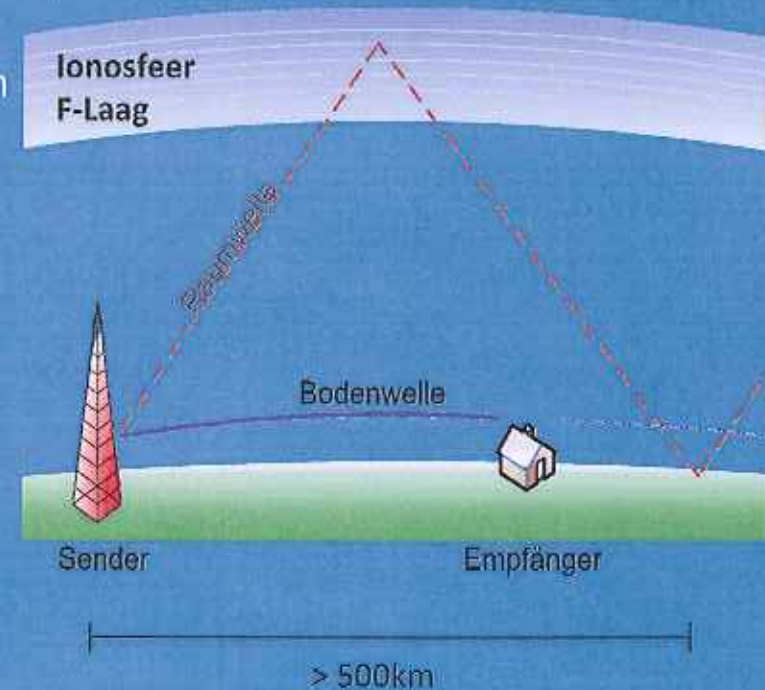

# EFR varianten

▶ Individuele lichtmastontvanger

▶ Kastontvanger

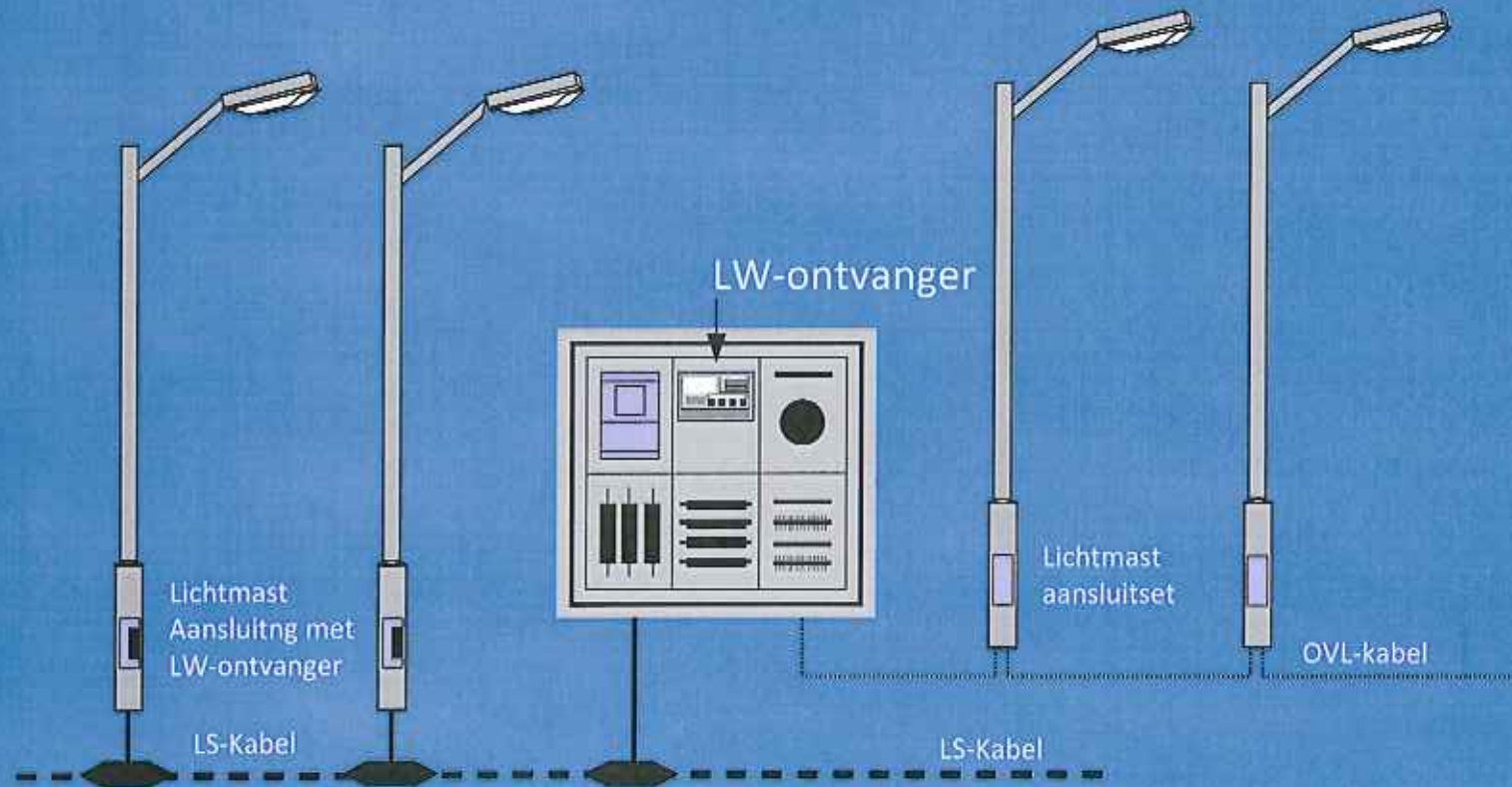

# Langmatz ontvangers

Kastuitvoering

Mastuitvoering

Tijdsynchronisatie elke 10 seconden

Commandoduur 10 – 12 sec.

Programmering via optische aansluiting  
en ToolLIC software

Standaard ingebouwde antenne,  
Aansluiting voor externe antenne



# EFR-Europäische Funk-Rundsteuerung

Zelf in- en uitschakeltijden bepalen

Activeren van dimmen

Onafhankelijkheid van  
Het netwerkbedrijf

Kostenreductie

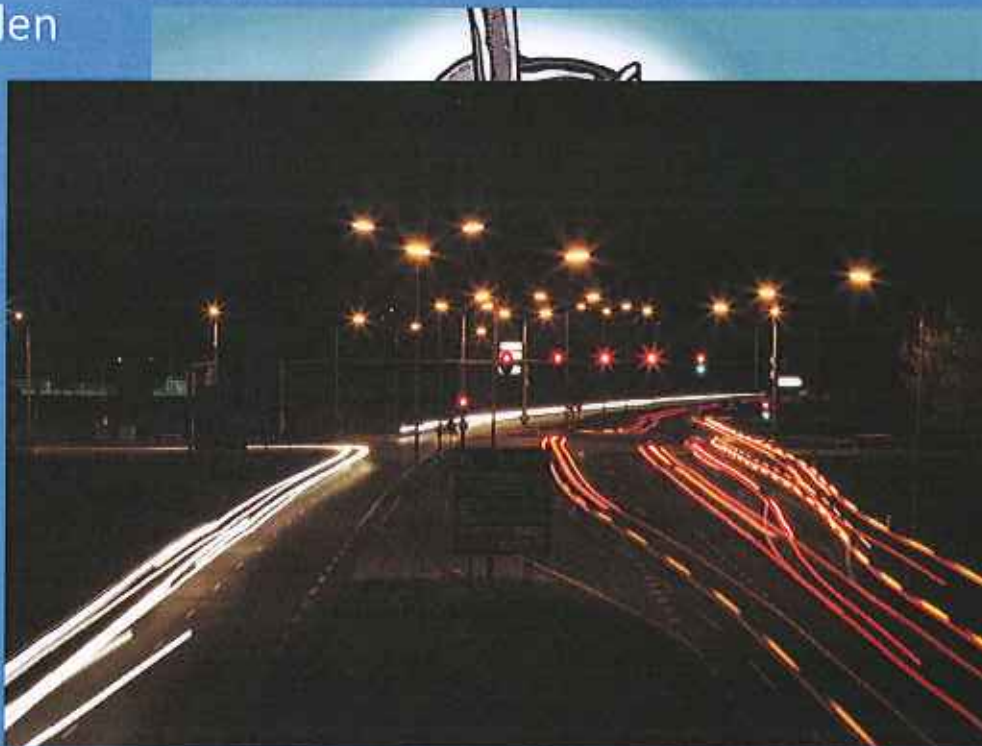

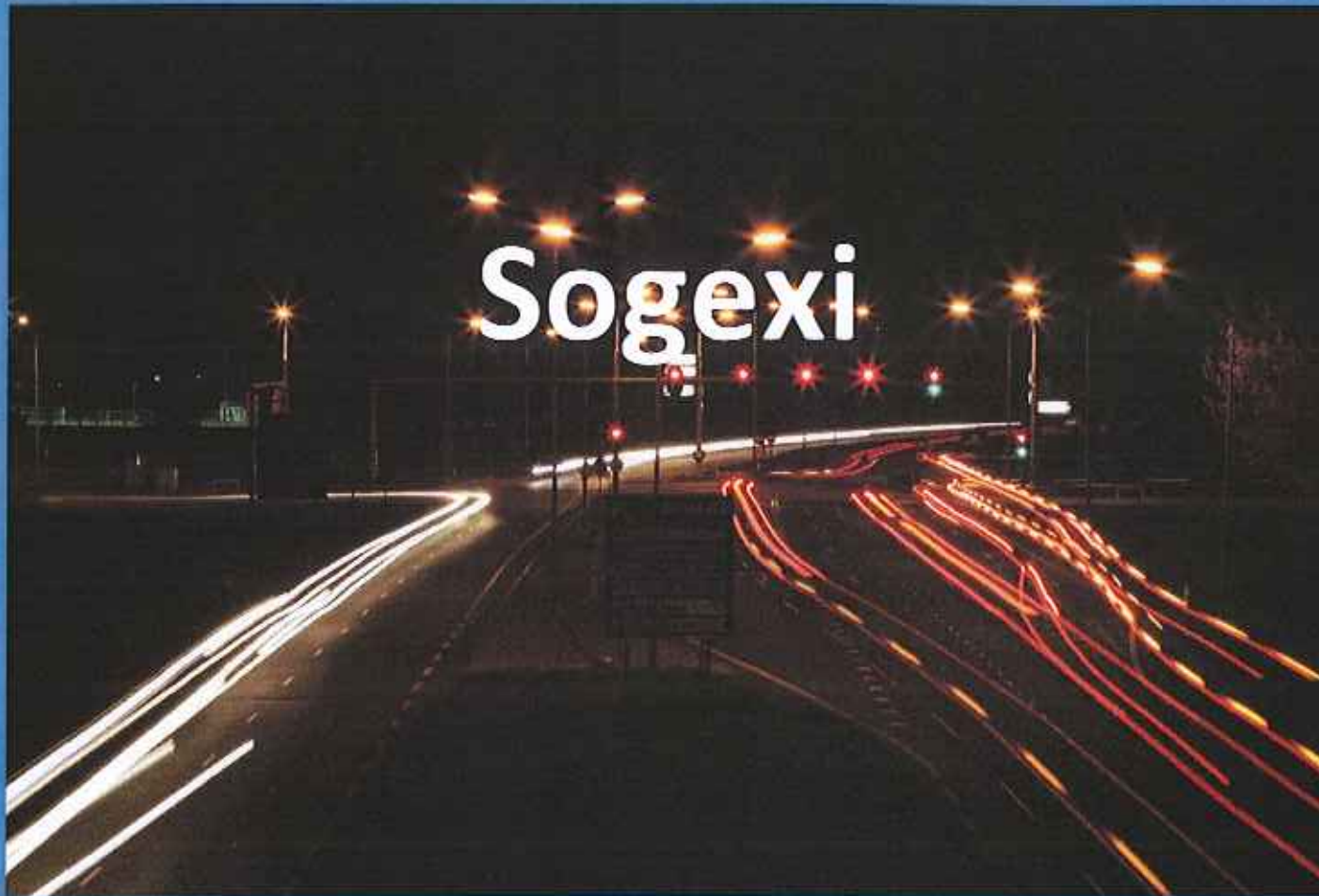

## e-Pak

Elektronische vsa's voor SON en CDO lampen  
van 50 t/m 150W en CPO 60 t/m 140W

Geïnstalleerd in de mast in combinatie met een  
Langmatz lichtmastset, ook als retrofit (IP65 / 54)

Voordeel in onderhoud en schadeoplossing

Technische levensduur 60.000 branduur (Tc max 20°C)



**elspec**



# e-Pak Overzicht

E-Pak IT2



E-Pak ITD



E-Pak ITP



E-Pak DALI

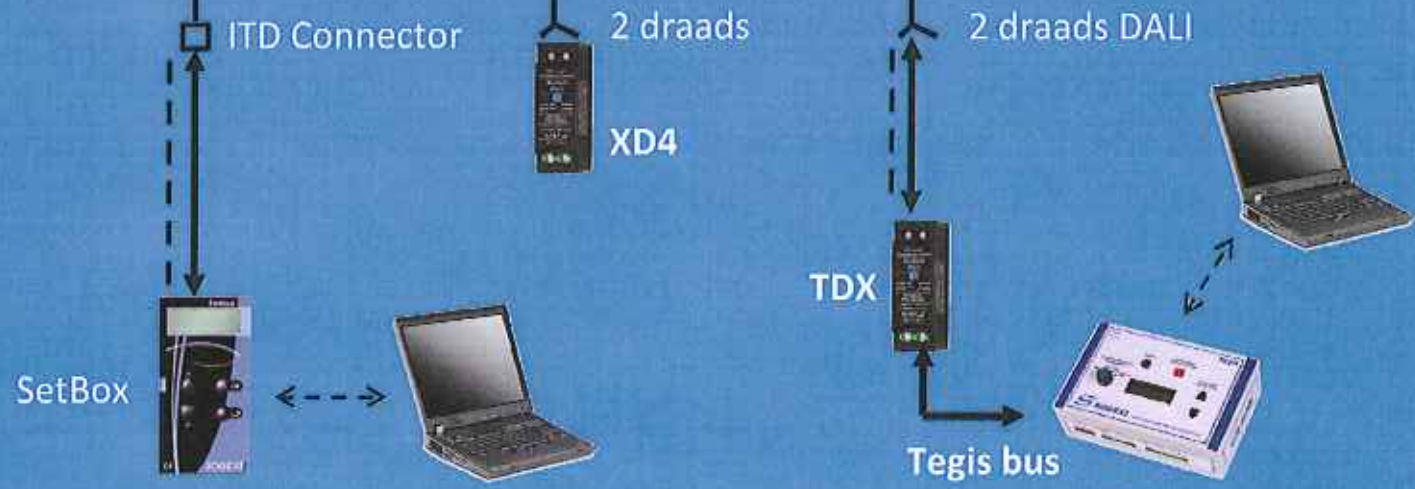



# TEGIS lichtmanagement systeem



TDX of TMX module  
in lichtmastset



TEGIS Centrale management unit  
in de OV-kast



GPRS modem of  
ethernetinterface  
in OV- kast



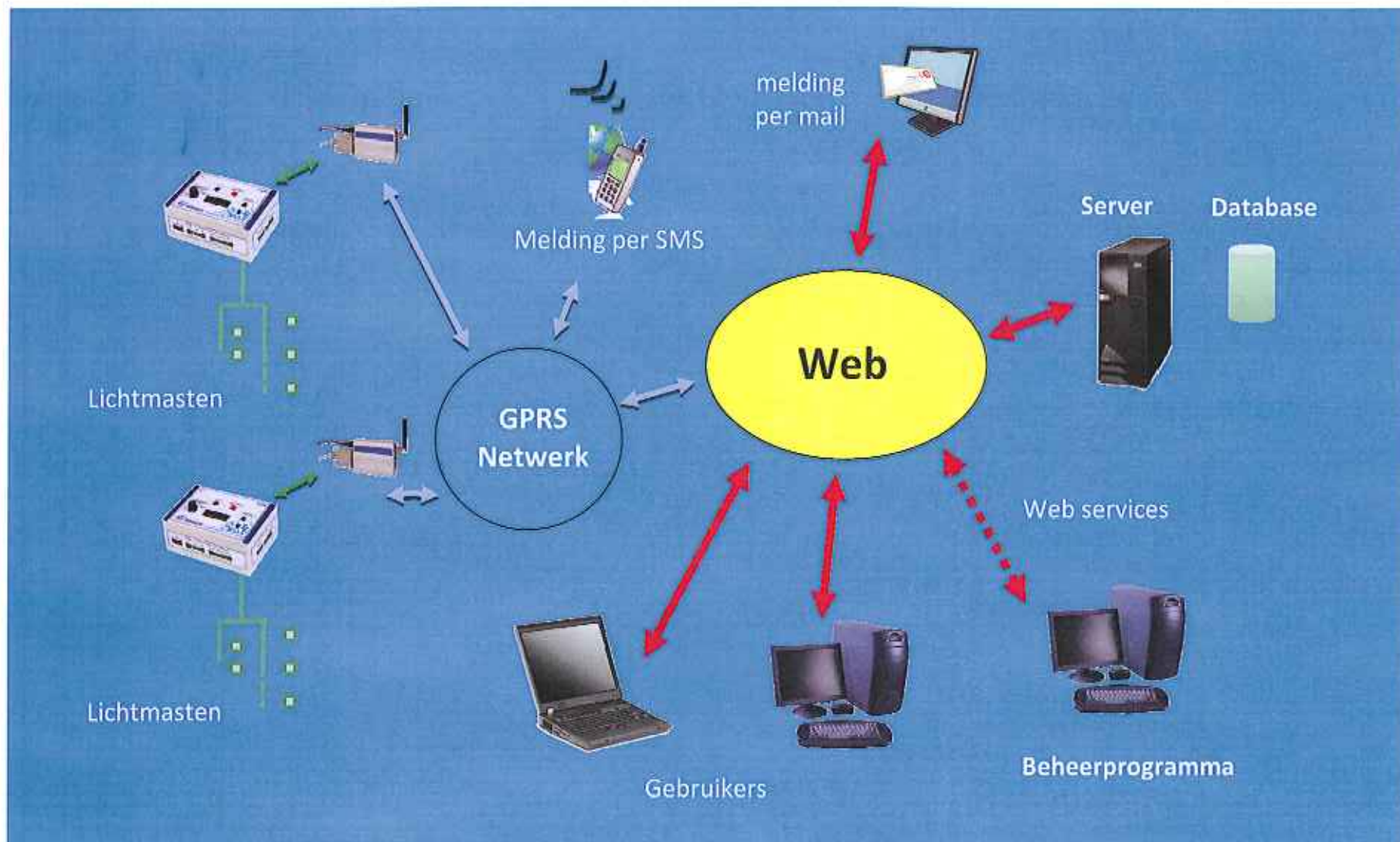

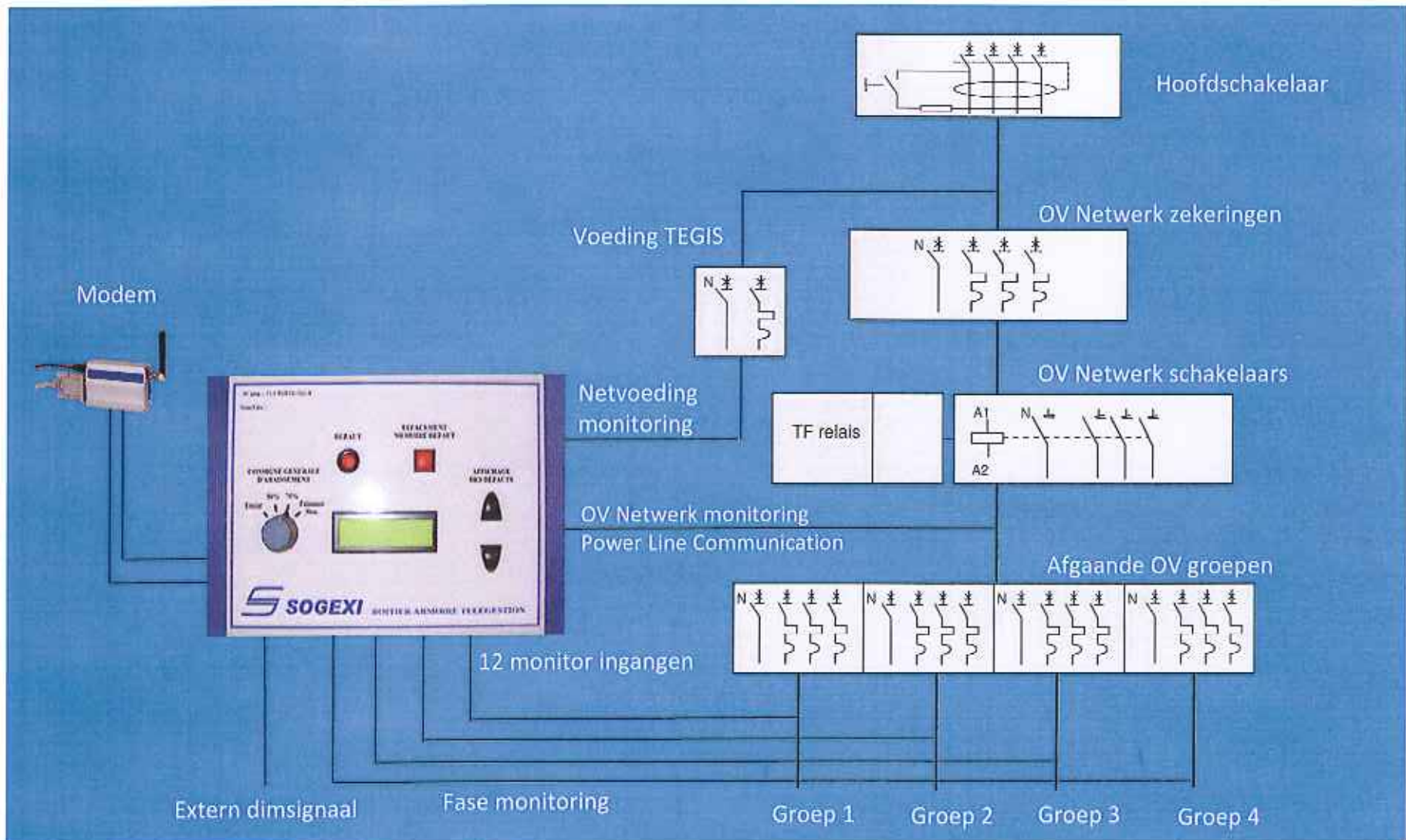

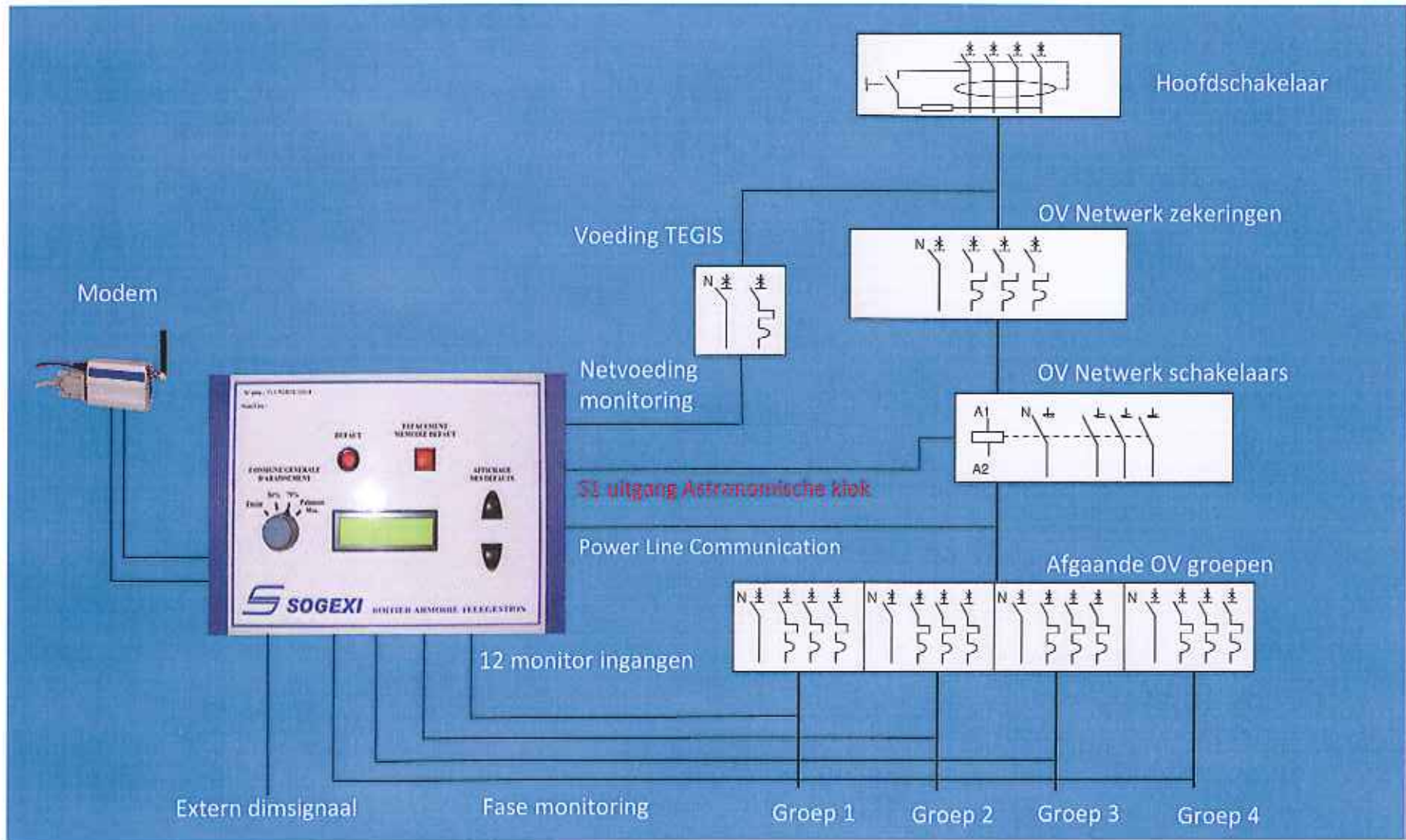



M2M Operating Portal v2.2 - Dashboard-2.2.3.4 - Windows Internet Explorer

http://sogexi.anyware-tech.com/portal/flashbaord.jsp

Favorieten M2M Operating Portal v2.2 - Dashboard-2.2.3.4

TEGIS CPU details

Group: Labo  
Name: Parking SOGEXI  
Serial number: TLD

**tegis** La Télégestion de réseaux d'Eclairage Public

Events Details **Lights points** Input/output SL command Consumption Contact

### General lowering management

Lowering type:  Internal  Permanent cycle  
 External  Weekly cycle

	Monday	Tuesday	Wednesday	Thursday	Friday	Saturday	Sunday
Time slot N°1	Hours: 21	Minutes: 22	Power: 75%	Clear			
Time slot N°2	Hours: 22	Minutes: 21	Power: 50%	Clear			
Time slot N°3	Hours: 22	Minutes: 54	Power: 0%	Clear			
Time slot N°4	Hours: 23	Minutes: 25	Power: 50%	Clear			
Time slot N°5	Hours: 2	Minutes: 56	Power: Switch positi	Clear			
Time slot N°6	Hours: 3	Minutes: 56	Power: 100%	Clear			

Save

### Lights address list

Addresses	Alias
09.03.048.003	
09.03.048.004	
09.03.048.005	
09.03.048.006	
08.39.049.001	
08.39.049.002	
09.03.048.007	
05.18.111.016	Parking 16

No item

Import light address aliases list

Address to modify \*

Add Delete

Close

Gereed Internet 105%



M2M Operating Portal v2.2 - Dashboard 2.2.3.4 - Windows Internet Explorer

http://sogexi.anyware-tech.com/portal/dashboard.jsp

M2M Operating Portal v2.2 - Dashboard 2.2.3.4

TEG15 TPU details



Events Details Light points Input/output

Astronomical clock (6.1) [Clock history \(6.2\)](#)

Schedules on-off

Monday	Off	07	:	01	On	24
Tuesday	Off	07	:	02	On	24
Wednesday	Off	07	:	03	On	24
Thursday	Off	07	:	04	On	24
Friday	Off	07	:	05	On	24
Saturday	Off	07	:	06	On	24
Sunday	Off	07	:	07	On	24
Special days - Profile 1	Off	07	:	08	On	24
Special days - Profile 2	Off	07	:	09	On	24

Select special days

Special days selection - Fixed hours clock

Jan-Feb-Mar			Apr-May-Jun			Jul-Aug-Sept			Oct-Nov-Dec		
January	Profile 1	Profile 2	February	Profile 1	Profile 2	March	Profile 1	Profile 2			
01-jan	<input type="checkbox"/>	<input type="checkbox"/>	01-feb	<input type="checkbox"/>	<input type="checkbox"/>	01-mar	<input type="checkbox"/>	<input type="checkbox"/>			
02-jan	<input type="checkbox"/>	<input type="checkbox"/>	02-feb	<input type="checkbox"/>	<input type="checkbox"/>	02-mar	<input type="checkbox"/>	<input type="checkbox"/>			
03-jan	<input type="checkbox"/>	<input type="checkbox"/>	03-feb	<input type="checkbox"/>	<input type="checkbox"/>	03-mar	<input type="checkbox"/>	<input type="checkbox"/>			
04-jan	<input type="checkbox"/>	<input type="checkbox"/>	04-feb	<input type="checkbox"/>	<input type="checkbox"/>	04-mar	<input type="checkbox"/>	<input type="checkbox"/>			
05-jan	<input type="checkbox"/>	<input type="checkbox"/>	05-feb	<input type="checkbox"/>	<input type="checkbox"/>	05-mar	<input type="checkbox"/>	<input type="checkbox"/>			
06-jan	<input type="checkbox"/>	<input type="checkbox"/>	06-feb	<input type="checkbox"/>	<input type="checkbox"/>	06-mar	<input type="checkbox"/>	<input type="checkbox"/>			
07-jan	<input type="checkbox"/>	<input type="checkbox"/>	07-feb	<input type="checkbox"/>	<input type="checkbox"/>	07-mar	<input type="checkbox"/>	<input type="checkbox"/>			
08-jan	<input type="checkbox"/>	<input type="checkbox"/>	08-feb	<input type="checkbox"/>	<input type="checkbox"/>	08-mar	<input type="checkbox"/>	<input type="checkbox"/>			
09-jan	<input type="checkbox"/>	<input type="checkbox"/>	09-feb	<input type="checkbox"/>	<input type="checkbox"/>	09-mar	<input type="checkbox"/>	<input type="checkbox"/>			
10-jan	<input type="checkbox"/>	<input type="checkbox"/>	10-feb	<input type="checkbox"/>	<input type="checkbox"/>	10-mar	<input type="checkbox"/>	<input type="checkbox"/>			
11-jan	<input type="checkbox"/>	<input type="checkbox"/>	11-feb	<input type="checkbox"/>	<input type="checkbox"/>	11-mar	<input type="checkbox"/>	<input type="checkbox"/>			
12-jan	<input type="checkbox"/>	<input type="checkbox"/>	12-feb	<input type="checkbox"/>	<input type="checkbox"/>	12-mar	<input type="checkbox"/>	<input type="checkbox"/>			
13-jan	<input type="checkbox"/>	<input type="checkbox"/>	13-feb	<input type="checkbox"/>	<input type="checkbox"/>	13-mar	<input type="checkbox"/>	<input type="checkbox"/>			
14-jan	<input type="checkbox"/>	<input type="checkbox"/>	14-feb	<input type="checkbox"/>	<input type="checkbox"/>	14-mar	<input type="checkbox"/>	<input type="checkbox"/>			
15-jan	<input type="checkbox"/>	<input type="checkbox"/>	15-feb	<input type="checkbox"/>	<input type="checkbox"/>	15-mar	<input type="checkbox"/>	<input type="checkbox"/>			
16-jan	<input type="checkbox"/>	<input type="checkbox"/>	16-feb	<input type="checkbox"/>	<input type="checkbox"/>	16-mar	<input type="checkbox"/>	<input type="checkbox"/>			
17-jan	<input type="checkbox"/>	<input type="checkbox"/>	17-feb	<input type="checkbox"/>	<input type="checkbox"/>	17-mar	<input type="checkbox"/>	<input type="checkbox"/>			
18-jan	<input type="checkbox"/>	<input type="checkbox"/>	18-feb	<input type="checkbox"/>	<input type="checkbox"/>	18-mar	<input type="checkbox"/>	<input type="checkbox"/>			
19-jan	<input type="checkbox"/>	<input type="checkbox"/>	19-feb	<input type="checkbox"/>	<input type="checkbox"/>	19-mar	<input type="checkbox"/>	<input type="checkbox"/>			
20-jan	<input type="checkbox"/>	<input type="checkbox"/>	20-feb	<input type="checkbox"/>	<input type="checkbox"/>	20-mar	<input type="checkbox"/>	<input type="checkbox"/>			

Gereed Internet 105%



M2M Operating Portal v2.2 - Dashboard-2.2.3.4 - Windows Internet Explorer

http://sogexi.anyware-tech.com/portal/dashboard.jsp

Group: Labo  
Name: R&D  
Serial number: TLE80812/XX00

**SOGEXI** **tegis**

Events | Details | Light points | Input/output | SL command | Consumption | Contact

Date: From [ ] To [ ]  
Nature: All natures  
Acknowledgement: Any  
[ Search ] [ Reset ]

### Events list

<input type="checkbox"/>	Date	Nature	Description	Acknowledgement
<input type="checkbox"/>	27/04/10 12:11		GSM/GPRS communication link fault	<input type="button" value="Acknowledge"/>
<input type="checkbox"/>	20/04/10 10:48		GSM/GPRS communication link fault	<input type="button" value="Acknowledge"/>
<input type="checkbox"/>	20/04/10 15:04		Power supply back	<input type="button" value="Acknowledge"/>
<input type="checkbox"/>	20/04/10 11:39		GSM/GPRS communication link fault	<input type="button" value="Acknowledge"/>
<input type="checkbox"/>	20/04/10 9:39		Tegis - Modem connection fault	<input type="button" value="Acknowledge"/>
<input type="checkbox"/>	20/04/10 9:33		Power supply down	<input type="button" value="Acknowledge"/>
<input type="checkbox"/>	20/04/10 9:33		SL working fault	<input type="button" value="Acknowledge"/>
<input type="checkbox"/>	20/04/10 8:56		Monitoring input fault 1 N° 2	<input type="button" value="Acknowledge"/>
<input type="checkbox"/>	20/04/10 8:06		Power supply back	<input type="button" value="Acknowledge"/>
<input type="checkbox"/>	19/04/10 18:47		GSM/GPRS communication link fault	<input type="button" value="Acknowledge"/>
<input type="checkbox"/>	19/04/10 17:25		SL working fault	<input type="button" value="Acknowledge"/>
<input type="checkbox"/>	19/04/10 17:25		Power supply down	<input type="button" value="Acknowledge"/>

<< < | 1 | 2 | > >> 1-12/22

Contact Us | About | Legal | Privacy Policy | © 2009 Sierra Wireless - All Rights Reserved

Gereed Internet 105%



M2M Operating Portal v2.2 - Dashboard-2.2.3.4 - Windows Internet Explorer

http://sogexi.anyware-tech.com/portal/dsdbboard.jsp

M2M Operating Portal v2.2 - Dashboard-2.2.3.4

TEGIS CPU details

**SOGEXI**

Group Labo  
Name Parking SOGEXI  
Serial number TLD

**tegis** Street lighting network management

Events Details Light points Input/output SL command **Consumption** Contact

**Electric meter**

Meter address	123123123123
Tariff option	BASE
Subscribed intensity	12 A

**Filter**

Date From  To

**Index list**

SL startup	SL disconnection	Index (Wh)	SL consum. (Wh)	SL duration (hh:mm)
20/04/10 19:12	21/04/10 8:09	1698166	10326	12:57
19/04/10 19:10	20/04/10 8:10	1697840	23359	13:00
17/04/10 19:14	18/04/10 8:09	1664482	21769	12:55
16/04/10 16:51	16/04/10 16:52	1642713	1472352	00:01
15/04/10 19:17	16/04/10 8:07	170361	0	12:50
14/04/10 19:19	15/04/10 8:05	170361	0	12:46
13/04/10 19:24	14/04/10 8:04	170361	0	12:40
12/04/10 19:25	13/04/10 8:00	170361	0	12:35
11/04/10 19:27	12/04/10 7:59	170361	0	12:32
10/04/10 19:29	11/04/10 7:57	170361	0	12:28
09/04/10 19:01	10/04/10 7:57	170361	0	12:05

<< | < | 1 | **2** | 3 | 4 | > | >> 1-12/39

Gereed Internet 105%



M2M Operating Portal v2.2 - Dashboard 2.2.3.4 - Windows Internet Explorer

http://sogexi.anyware-tech.com/portal2/dashboard.jsp

Favorieten M2M Operating Portal v2.2 - Dashboard-2.2.3.4

**SOGEXI**  
L'équipementier de l'éclairage public  
Equipment for street lighting

**tegis**

administration asset management

User: stéphane (CLEYENOT)  
Time zone: Europe/Paris UTC+2  
Charge user settings

Asset Management : SOGEXI\_R&D / Labo

- AGP
- AREL
- BARADEL
- CEEC
- DUPRAY
- ELECTROFLUID
- ETUDEQUIPE
- FINEC
- LE MATERIEL DE RESEAUX
- LISSIEU
- LUMIRU
- NOREP
- PRYSMA
- SOGEXI
- SOGEXI\_R&D
  - SOGEXI\_R&D
    - Labo
    - SZAV
- VILLEFRANCHE SUR SAÔNE
- VISION

Assets Events Google Map

POWERS BY Google

Kaartgegevens ©2010 Tele Atlas

Gereed Internet 105%





# Eurel draadloos lichtmanagement



# Eurel lichtmanagement systeem

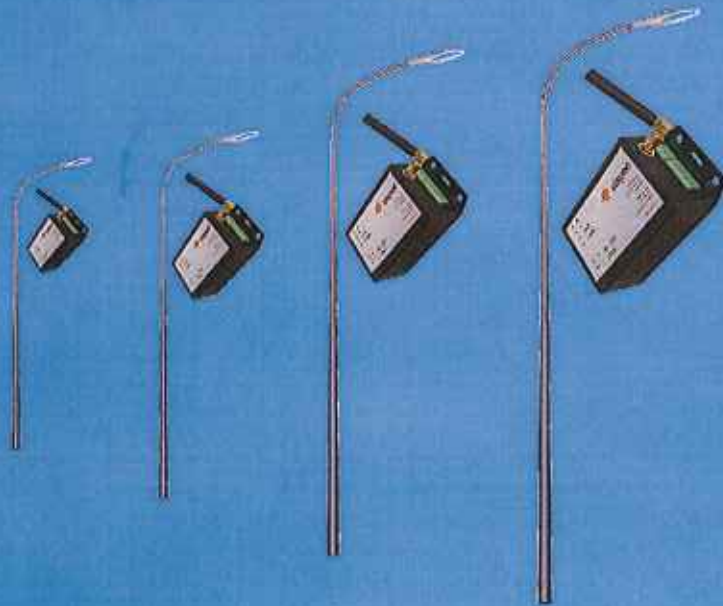

e-OLC nodes in lichtmasten



Gateway



Portal



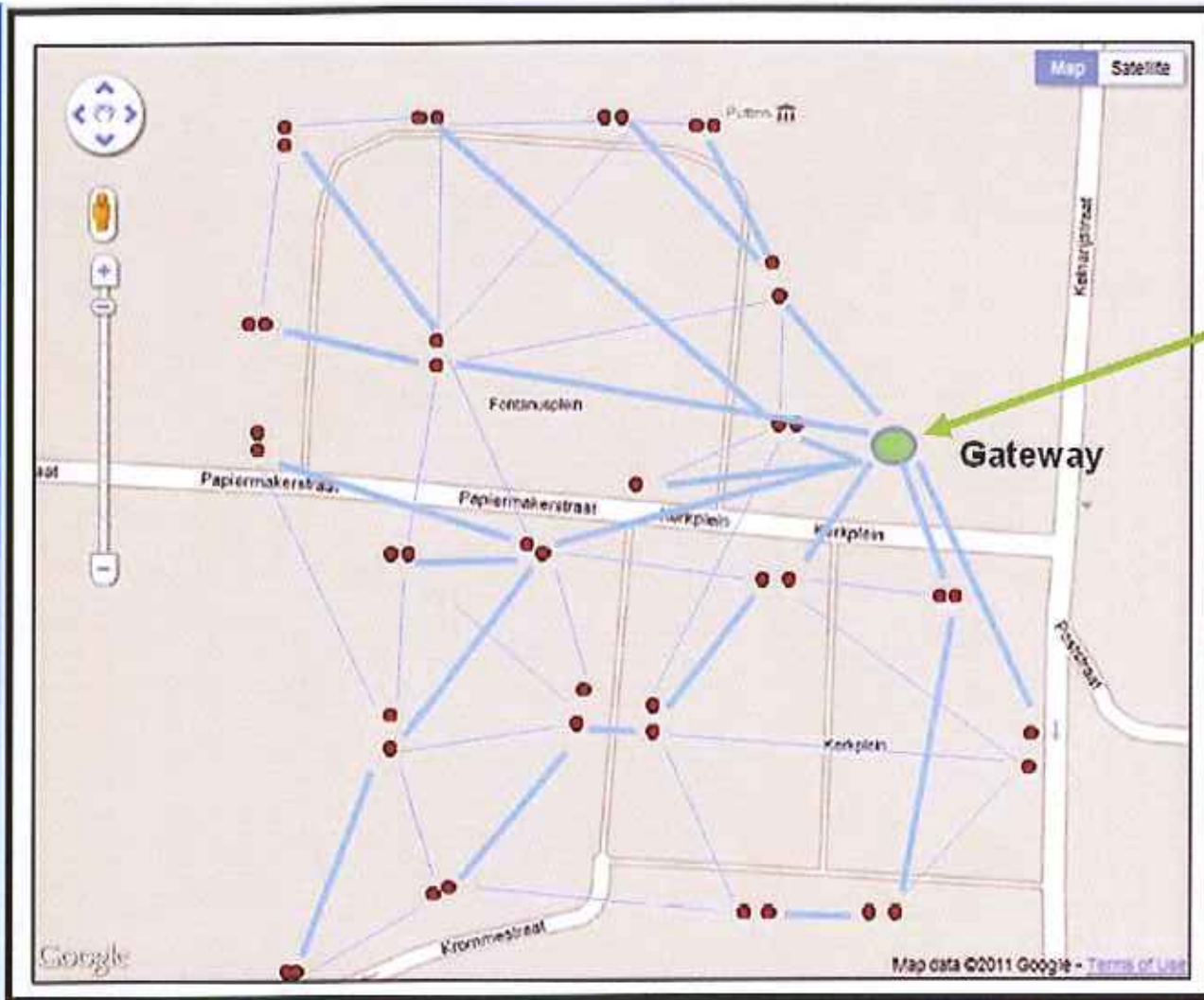

Mobiel internet



ZigBee®



elspec

# Portal

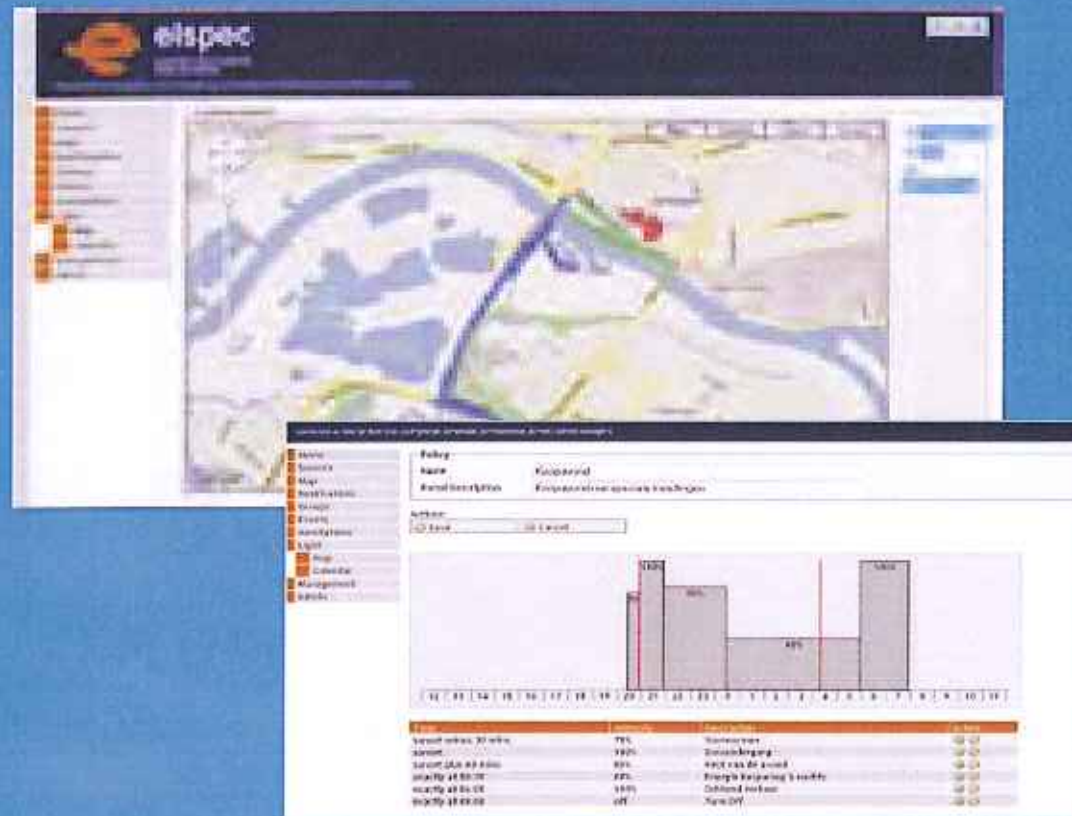

munisense.net - Streetlight Uitgebreid - Mozilla Firefox

Bestand Beveiligen Beeld Geschiedenis Bladvijzers Extra Help

https://elspec-licht.munisense.net/viewsets.php?viewset\_id=21

munisense.net - Streetlight Uitgebreid

**elspec**  
ELEKTRO TECHNISCHE  
SPECIALITEITEN

Overview

- Emergency
- Map
- Timeline
- Groups

Dim configuration

- Dim profile
- Dim calendars

Streetlights

- Override
- Modify Group

Network

- Topology
- Installation

Admin

This image is updated every 60 seconds.

Papiermakersstraat, Puffin  
Adress & approach

Group / Property selection

- Group
- Property

Real Value Type

- Bullets
- Labels

Groups

- Determinite Elspec
- Fontanusplein
- Kerkplein

© 2011 Microsoft

Klaar



munisense.net - Streetlight Uitgebreid - Mozilla Firefox

Bestand Reageren Beeld Geschiedenis Bladvolgers Extra Help

munisense.net | https://elspec-licht.munisense.net/Newssets.php?action=edit&id=12

munisense.net - Streetlight Uitgebreid

**elspec**  
ELEKTROTECHNISCHE  
SPECIFIJETER

Overviews

- Emergency
- Map
- Timeline
- Groups
- Dim configuration
- Dim profile
- Dim calendars
- Streetlights
- Override
- Modify Group
- Network
- Topology
- Installation
- Admin

**Calendar Day**

90% 100% 50%

0 1 2 3 4 5 6 7 8 9 10 11 12 13 14 15 16 17 18 19 20 21 22 23

**Calendar**

Description:

Time	Level	Action
00:00:00	50%	↓
06:00:00	100%	↓
22:00:00	80%	↓
23:00:00	50%	↓

Actions:

© 2011 Munisense

4 | Klaar



**elspec**



munisense.net - Streetlight Uitgebreid - Mozilla Firefox

Bestand Beveiligen Beeld Geschiedenis Bijdragers Extra Help

munisense.net https://elspec-licht.munisense.net/viewsets.php?action=edit&id=25&year=2011

munisense.net - Streetlight Uitgebreid

**elspec**  
ELEKTROTECHNISCHE  
SPECIALITEITEN

Select:  Su  Mo  Tu  We  Th  Fr  Sa  All  HD

**January**

Su	Mo	Tu	We	Th	Fr	Sa
52	26	27	28	29	30	31
1	2	3	4	5	6	7
2	8	9	10	11	12	13
3	14	15	16	17	18	19
4	20	21	22	23	24	25
5	26	27	28	29	30	31

**February**

Su	Mo	Tu	We	Th	Fr	Sa
5	31	1	2	3	4	5
6	6	7	8	9	10	11
7	12	13	14	15	16	17
8	18	19	20	21	22	23
9	24	25	26	27	28	29

**March**

Su	Mo	Tu	We	Th	Fr	Sa
9	27	28	29	30	31	1
10	2	3	4	5	6	7
11	8	9	10	11	12	13
12	14	15	16	17	18	19
13	20	21	22	23	24	25
14	26	27	28	29	30	31

**April**

Su	Mo	Tu	We	Th	Fr	Sa
13	27	28	29	30	1	2
14	3	4	5	6	7	8
15	9	10	11	12	13	14
16	15	16	17	18	19	20
17	21	22	23	24	25	26
18	27	28	29	30	1	2

**May**

Su	Mo	Tu	We	Th	Fr	Sa
10	1	2	3	4	5	6
19	7	8	9	10	11	12
20	13	14	15	16	17	18
21	19	20	21	22	23	24
22	25	26	27	28	29	30

**June**

Su	Mo	Tu	We	Th	Fr	Sa
22	26	27	28	29	30	1
23	2	3	4	5	6	7
24	8	9	10	11	12	13
25	14	15	16	17	18	19
26	20	21	22	23	24	25
27	26	27	28	29	30	1

**July**

Su	Mo	Tu	We	Th	Fr	Sa
26	24	25	26	27	28	29
27	3	4	5	6	7	8
28	9	10	11	12	13	14
29	15	16	17	18	19	20
30	21	22	23	24	25	26
31	27	28	29	30	31	1

**August**

Su	Mo	Tu	We	Th	Fr	Sa
31	1	2	3	4	5	6
32	7	8	9	10	11	12
33	13	14	15	16	17	18
34	19	20	21	22	23	24
35	25	26	27	28	29	30

**September**

Su	Mo	Tu	We	Th	Fr	Sa
35	29	30	1	2	3	4
36	5	6	7	8	9	10
37	11	12	13	14	15	16
38	17	18	19	20	21	22
39	23	24	25	26	27	28
40	29	30	1	2	3	4

**Year**

Select a Year

[2010](#) [2011](#) [2012](#)

**Update Days**

Select days and apply:

Werkdag  
 Koopavond  
 Weekend  
 Save the planet earth  
 Vuurwerk

**Calendar**

Description

Standaard kalender

Days

Unchanged

Klaar



**elspec**



munisense.net - Streetlight Uitgebreid - Mozilla Firefox

Bestand Beveiliging Beeld Geschiedenis Bijwerken Eten Help

munisense.net https://ekspec-licht.munisense.net/Views/sets.php?action=editremote&id=69

munisense.net - Streetlight Uitgebreid

**Streetlight**

**Node**

Identify Time  seconds

**Level**

Current  %

Transition Time  seconds

**Ballast**

Ballast Factor  %

Intrinsic Factor  %

Depreciation Factor  %

PowerOn Level  %

PowerOn FadeTime  seconds

Min Level  %

Max Level  %

**Lamp**

Rated Hours  hours

Burn Hours  hours

Klaar



**elspec**



munisense.net - Streetlight Uitgebreid - Mozilla Firefox

munisense.net https://elspec-licht.munisense.net/viewsets.php?action=view&id=69

munisense.net - Streetlight Uitgebreid

**elspec**  
ELECTRO TECHNISCHE  
SPECIALITEITEN

Streetlight

**Object Properties**

Id	69
Description	de kwakei- PLL 36w
Location	Bedrijvenweg 14, 1424 De Kwakei,
Netherlands	

**Node**

Node	ostc1ab0006
Euro4	000d:6f00:00:b1bc25
Model Identifier	MSLC1-0160
Datecode	20110303
Temperature	55.50 °C
Time	08/07/2011 09:00:12
Identify Time	0 seconds

**Pole properties**

Description	
Manufacturer	
Type	
Height	0 cm

**Armature properties**

Description	PLL Armatuur
Manufacturer	Philips
Type	FGS224 PL-L36W

**Ballast**

Description	Dimbaar VSA 1-10V
Manufacturer	Philips
Type	HF-R 136 PLL EII
Status	NonOperational
Level	100 %
Version	5
CurrentPower	33 Watt
Energy/Water	3.202 kWh
PowerOn Level	100 %
PowerOn FadeTime	10.0 seconds
Ballast Factor	100 %
Intrinsic Factor	100 %
Depreciation Factor	0 %
Min Level	0.1 %
Max Level	100 %
Physical Min Level	0.1 %
Physical Max Level	100 %

**Level**

Calendar	Standaard kalender
Current	100 %
Status	FollowCalendar
Transition Time	10.0 seconds
Remaining Time	0.0 seconds
Override	Level: 100 % Duration: 1 hour, 40 mins Timestamp: 06/07/2011 16:48:24 FadeTime: 1 sec Adjustment Level: 100 %

**Relais**

Relais On/Off	off
Relais On/Off Level	0 %

**Lamp**

Description	Compact fluorescentielamp
Manufacturer	Philips
Type	PLL 36W-830
Quantity	1
Rated Power	64 Watt
Rated Hours	10000 hours
Burn Hours	96 hours

Klaar



**elspec**



munisense.net - Streetlight Uitgebreid - Mozilla Firefox

munisense.net https://elspec-licht.munisense.net/viewsels.php?action=view&id=69

munisense.net - Streetlight Uitgebreid



Streetlight

**Object Properties**

Id	69
Description	de kwakel- PLL 36w
Location	Bedrijvenweg 14, 1424 De Kwakel, Netherlands
Mode	
Node	estc1ab0006
Eui64	000d:6f00:004b:bc25
Model Identifier	MSLC1-R160
Datecode	20110303
Temperature	55.50 °C
Time	08/07/2011 09:00:12
Identify Time	0 seconds

**Armature properties**

Description	PLL Armatuur
Manufacturer	Philips
Type	FG5224 PL-L36W

**Ballast**

Description	Dimbaar VSA 1-10V
Manufacturer	Philips
Type	HP-R 136 PLL EII
Status	NonOperational
Level	100 %
Version	5
CurrentPower	33 Watt
EnergyMeter	3.202 kWh
PowerOn Level	100 %
PowerOn FadeTime	10.0 seconds
Ballast Factor	100 %
Intrinsic Factor	100 %
Depreciation Factor	0 %
Min Level	0.1 %
Max Level	100 %
Physical Min Level	0.1 %
Physical Max Level	100 %

**Level**

Calendar	Standaard kalender
Current	100 %
Status	FollowCalendar
Transition Time	10.0 seconds
Remaining Time	0.0 seconds
Override	Level: 100 % Duration: 1 hour, 40 mins Timestamp: 06/07/2011 16:48:24 FadeTime: 1 sec Adjustment Level: 100 %

**Relais**

Relais On/Off	off
Relais On/Off Level	0 %

**Lamp**

Description	Compact fluorescentlamp
Manufacturer	Philips
Type	PLL 36W- 830
Quantity	1
Rated Power	64 Watt
Rated Hours	10000 hours
Burn Hours	96 hours

Klaar



munisense.net - Streetlight Uitgebreid - Mozilla Firefox

Bestand Beveiligen Beeld Geschiedenis Bladvijzers Extra Help

munisense.net https://elspec-licht.munisense.net/results.php?order\_dir=asc&order\_field=timestamp&action=graph&advanced\_info=advanced\_settings=8c

munisense.net - Streetlight Uitgebreid

- Modify Group
- Network
- Topology
- Installation
- Admin

Sample rate:  seconds (when empty, default: 1 min)  override max sample rate

Actions:

**Graph**

Bedrijvsweg 14, 1424 DE Kwaakel, Netherlands - Energy Meter (id:11ab0000)

Power Consumption in Watts

17/06/2011 00:00:00 - 17/07/2011 00:00:00 (1 month) min: 164200

Bedrijvsweg 14, 1424 DE Kwaakel, Netherlands - Energy Meter (id:11ab0000)

Power Consumption in Watts

Date	Power Consumption (Watts)	Percentage
17/06/2011	11	0.7%
18/06/2011	51	3.2%
19/06/2011	41	2.7%
20/06/2011	61	3.7%
21/06/2011	51	3.2%
22/06/2011	51	3.2%
23/06/2011	51	3.2%
24/06/2011	51	3.2%
25/06/2011	51	3.2%
26/06/2011	51	3.2%
27/06/2011	51	3.2%
28/06/2011	51	3.2%
29/06/2011	51	3.2%
30/06/2011	51	3.2%
01/07/2011	51	3.2%
02/07/2011	51	3.2%
03/07/2011	51	3.2%
04/07/2011	51	3.2%
05/07/2011	51	3.2%
06/07/2011	51	3.2%
07/07/2011	51	3.2%
08/07/2011	51	3.2%
09/07/2011	51	3.2%
10/07/2011	51	3.2%
11/07/2011	51	3.2%
12/07/2011	51	3.2%
13/07/2011	51	3.2%
14/07/2011	51	3.2%
15/07/2011	51	3.2%
16/07/2011	51	3.2%
17/07/2011	41	2.7%

17/06/2011 with resolution of 10 samples/1 min  
17/06/2011 00:00:00 - 17/07/2011 00:00:00 (1 month)

© 2011 Munisense

K388r

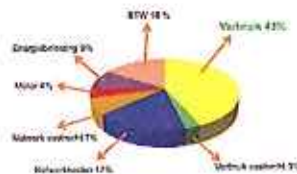



munisense.net - Streetlight Uitgebroid - Mozilla Firefox

Bestand Beveiliging Beeld Geschiedenis Bijgewijzers Extra Help

munisense.net https://elspec-licht.munisense.net/viewssets.php?viewset\_id=9

munisense.net - Streetlight Uitgebroid



**elspec**  
ELEKTRO TECHNISCHE  
SPECIALITEITEN

consulted at Arjan van Steenpoort

show help

- Overviews
- Emergency
- Map
- Timeline
- Groups
- Dim configuration
- Dim profile
- Dim calendars
- Streetlights
- Override
- Modify Group
- Network
- Topology
- Installation Support
- Admin

Alarm time: 100 minutes

Evenementenplan



1 out of 1 Objects are in Alarm mode in this group.  
Time remaining: 1:39:51

Successfully written 1 override(s) to the network.

© 2011 Munisense



# Voorbeeld



munisense.net - Streetlight Uitgebreid - Mozilla Firefox

Bestand Beveiligen Beeld Geavanceerde Afbeeldingen Extra Help

munisense.net https://elspec-licht.munisense.net/adminsettings.php

munisense.net - Streetlight Uitgebreid



**elspec**  
ELEKTRO TECHNISCHE  
SPECIALITEITEN

connected to Arjan van Steenpoort

**Overviews**

- Emergency
- Map
- Timeline
- Groups

**Dim configuration**

- Dim profile
- Dim calendars

**Streetlights**

- Override
- Modify Group

**Network**

- Topology
- Installation Support

**Admin**

- Settings
- Groups
- Nodes
- Attributes
- Users

**Administrator Settings**

Site Name:

Lines per Page:

Notifications:

E-mail template: 

Beste <name>  
  
 Een gebruikersaccount is aangemaakt op <site>. Op deze website krijgt u insage in de bij u in beheer gegeven openbare verlichtingsinstallatie.

Notification E-mail template: 

Beste <name>  
  
 Er is een lichtmaststoring op <site> gemeld. Wij verzoeken u deze binnen de contractueel afgesproken termijn te repareren.

Notification SMS template: 

<valuation>

Groups Limit: Unlimited

Actions:

© 2011 Munisense

Klaar



munisense.net - Streetlight Uitgebreid - Mozilla Firefox

Bestand Drukken Beeld Geschiedenis Bladvijzers Extra Help

munisense.net https://elspec-licht.munisense.net/viewsets.php?viewset\_id=88&selected\_property=armature\_description

munisense.net - Streetlight Uitgebreid

**elspec**  
ELEKTRO TECHNISCHE SPECIALITEITEN  
connected to Arjo via Standaard

show help

Group: Kerkplein

Update a property for several objects at once.

1. Select a property: Armature Description

2. Select the objects

Description	Armature Description	Actions
005127C003 Kerkplein	Indal Libra modificatie 4	<input checked="" type="checkbox"/>
005127C004 Kerkplein	Indal Libra modificatie 4	<input checked="" type="checkbox"/>
005127C005 Kerkplein	Indal Libra modificatie 4	<input checked="" type="checkbox"/>
005127C006 Kerkplein	Indal Libra modificatie 4	<input checked="" type="checkbox"/>
005127C007 Kerkplein	Indal Libra modificatie 4	<input checked="" type="checkbox"/>
005127C008 Kerkplein	Indal Libra modificatie 4	<input checked="" type="checkbox"/>
005127C009 Kerkplein	Indal Libra modificatie 4	<input checked="" type="checkbox"/>
005127C010 Kerkplein	Indal Libra modificatie 4	<input checked="" type="checkbox"/>
005127C011 Kerkplein	Indal Libra modificatie 4	<input checked="" type="checkbox"/>
005127C012 Kerkplein	Indal Libra modificatie 4	<input checked="" type="checkbox"/>
005127C013 Kerkplein	Indal Libra modificatie 4	<input checked="" type="checkbox"/>
005127C014 Kerkplein 33-40, 3881 Putten	Indal Libra modificatie 4	<input checked="" type="checkbox"/>
005127C015 Kerkplein 33-40, 3881 Putten	Indal Libra modificatie 4	<input checked="" type="checkbox"/>
005127C016 Kerkplein 33-40, 3881 Putten	Indal Libra modificatie 4	<input checked="" type="checkbox"/>
005127C027 Kerkplein 2, 3881 Putten	Indal Libra modificatie 4	<input checked="" type="checkbox"/>
005127C028 Kerkplein 2, 3881 Putten	Indal Libra modificatie 4	<input checked="" type="checkbox"/>

3. Set the new value for Armature Description:  Save

Klaar





Bedankt voor de aandacht  
Vragen?

